

To replace :

Type DLF1 (Kronenberg)  
with draw contact inside lock.

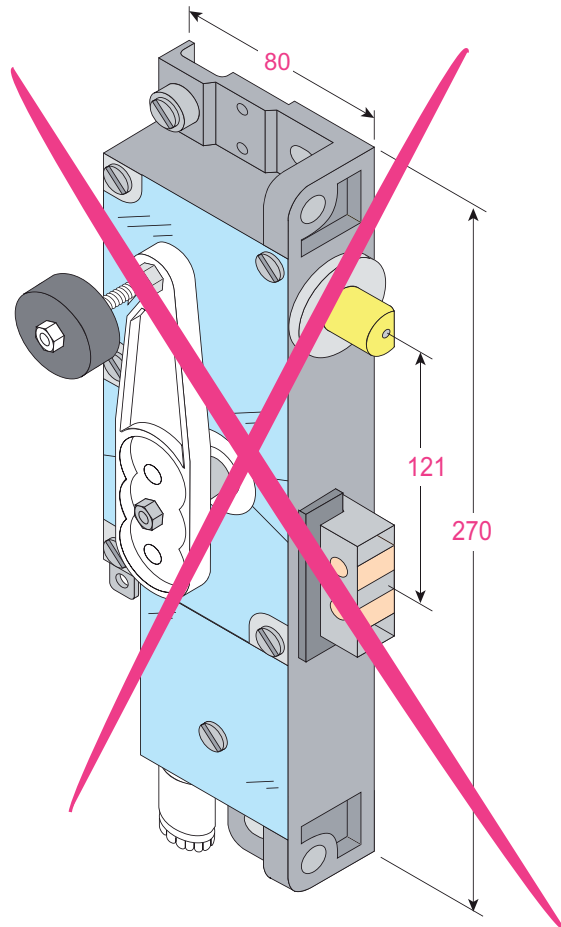

Substitution :

**LR 180 \*\* KRC** prudhomme S.a  
with draw contact CAop.

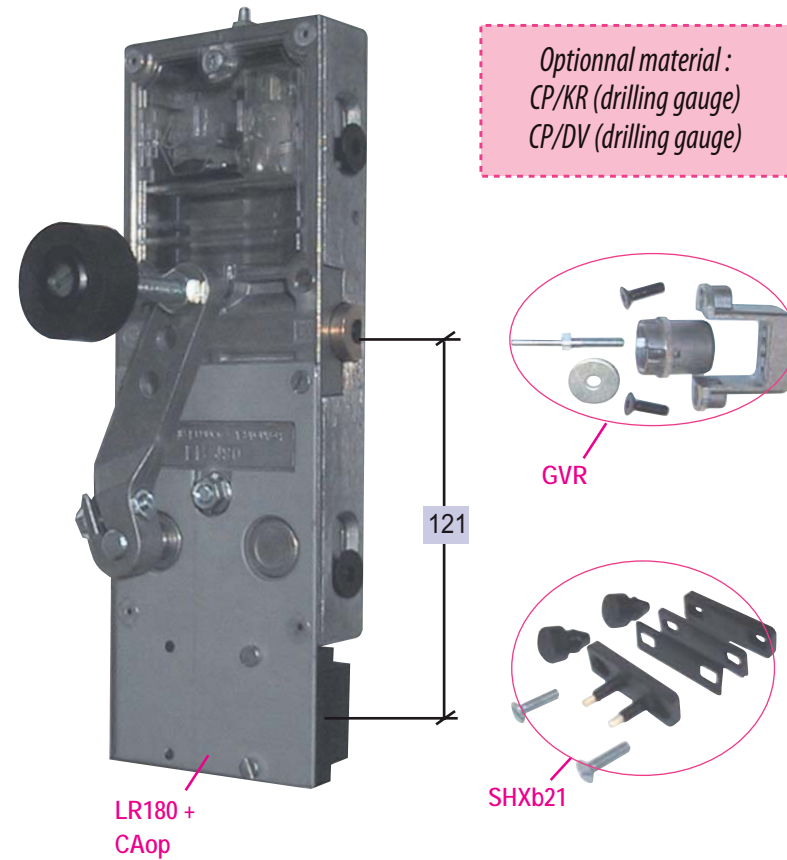

ref.: LR180 \* G KRC

ref.: LR180 \* D KRC

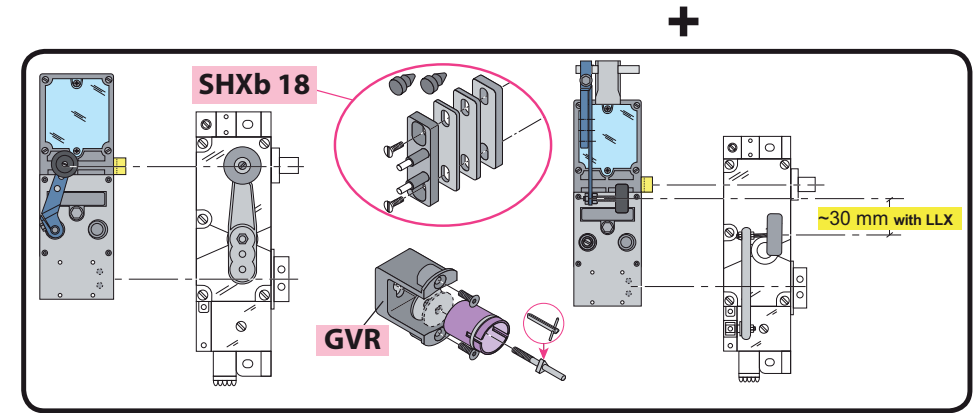
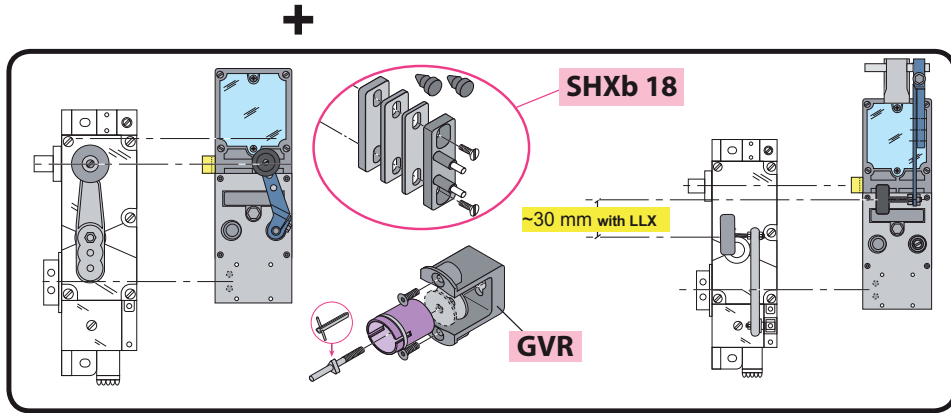
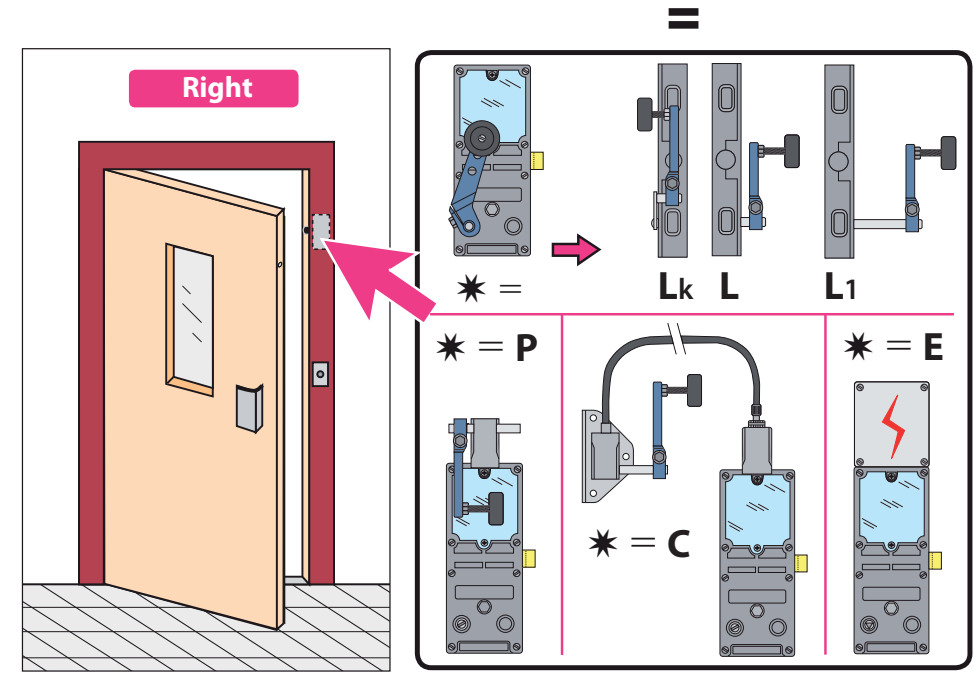
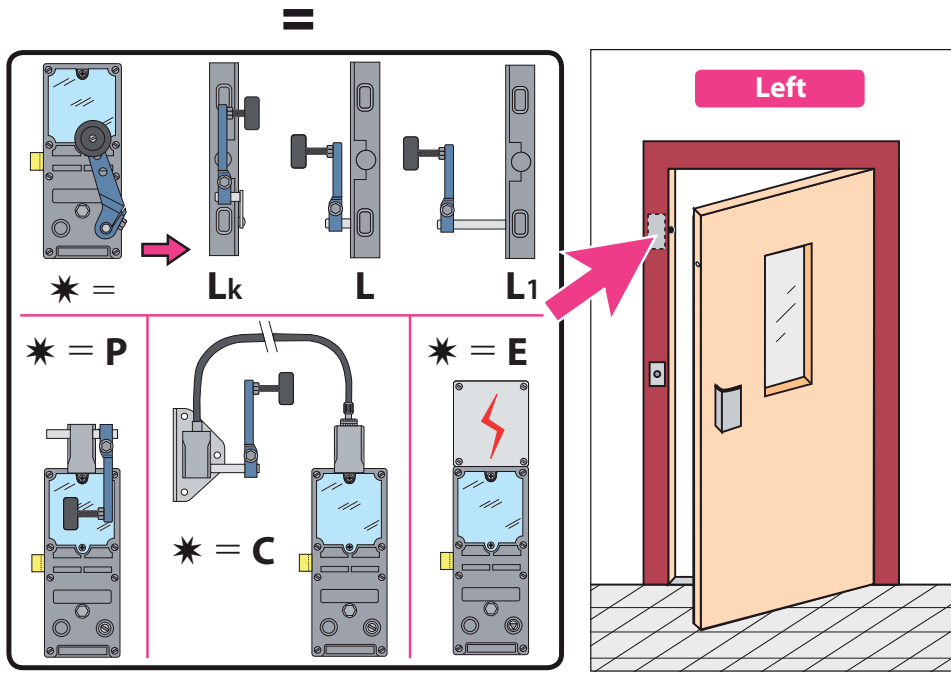

Mounting stages

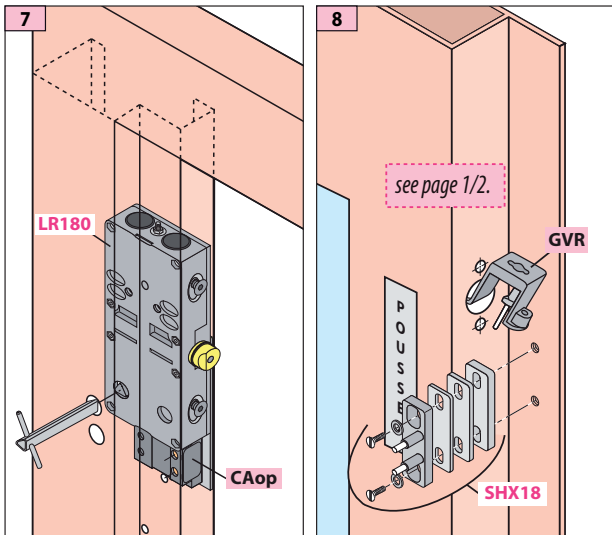
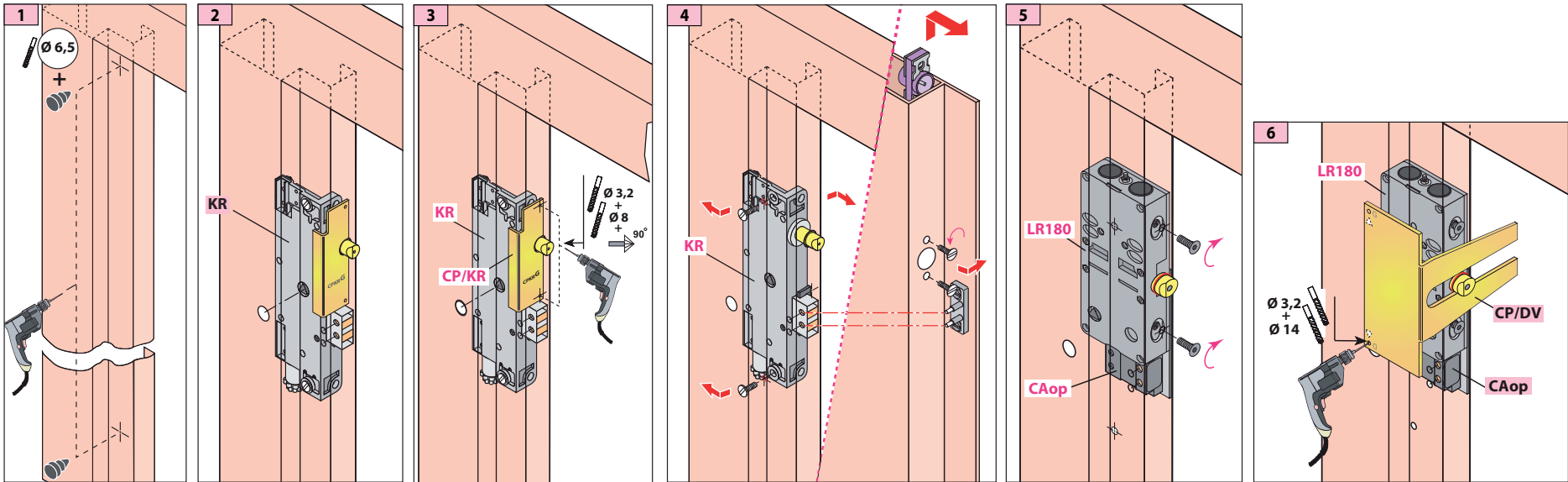
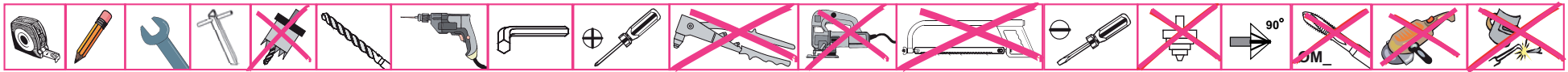

Pin adjustment

